

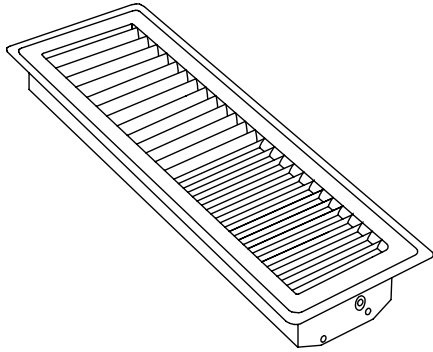

CSW Industrials Companies

Residential Submittal Premium Floor Register

MODEL: 375 Series



Standard Features:

- Heavy gauge steel construction
- Individually welded 16 guage diffusion bars
- Opposed Blade Damper standard on 4" width diffusers
- Lever operated Multi-Shutter Damper standard on 6" widths and larger
- All component parts, rivets, linkage, and handle, enclosed in valve to assure trouble-free operation
- Concealed locking mechanism available to hold damper in place for tamper-proof settings. Screw not included.
- Rust resistant pre-coat with durable powder finish
- Driftwood Tan

2 - 1/4" Widths

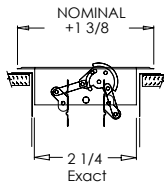

375 (2 1/4" Widths)

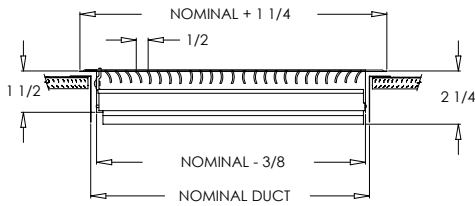

375 (2 1/4" Widths)

4" Widths

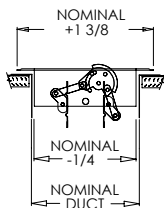

375 (4" Widths)

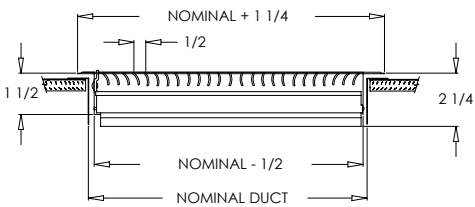

375 (4" Widths)

Finishes:

STANDARD COLORS

- Soft White
- Driftwood Tan

DESIGNER COLORS

- Black
- Bronze
- Storm Gray
- Cement Gray
- Aluminum Paint
- Coffee Tan
- Warm White
- Glossy White

6" Widths

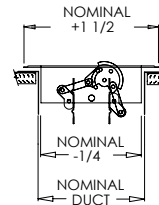

375 (6" Widths)

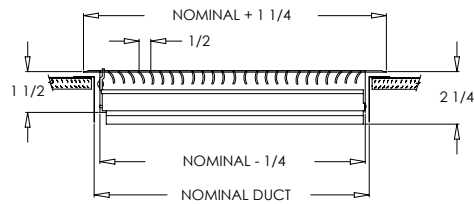

375 (6" Widths)

Additional Information:

Submittal Notes

Project / Location:

Engineer:

Architect:

Contractor: